



OPNFV

Open Platform for NFV ONOSFW Explained

Please direct any questions or comments to forum@onosfw.com or to <http://forum.onosfw.com>

Contents

- ONOSFW Framework for OPNFV/Structure Reference
- Interact and integrate with OpenStack projects
- Relationship with other OPNFV projects
- Supporting broader open initiatives
- Use cases Examples (control and message flows)



ONOSFW Relation to OPNFV

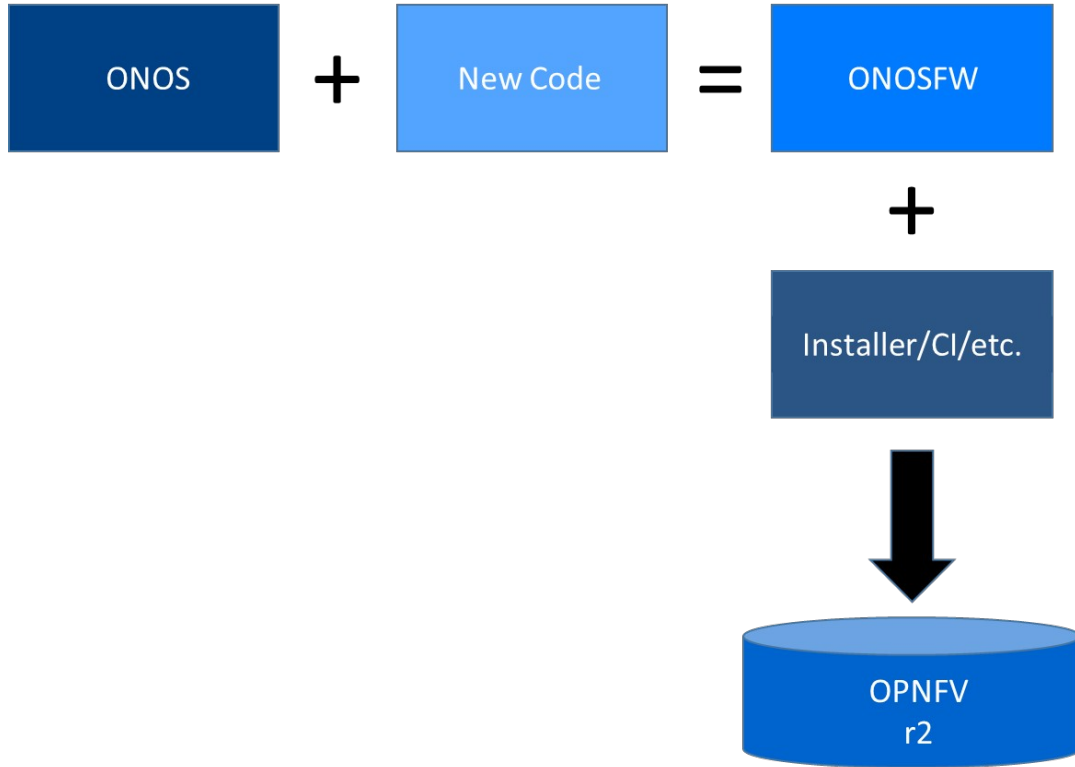

Reference: Where ONOSFW is in OPNFV

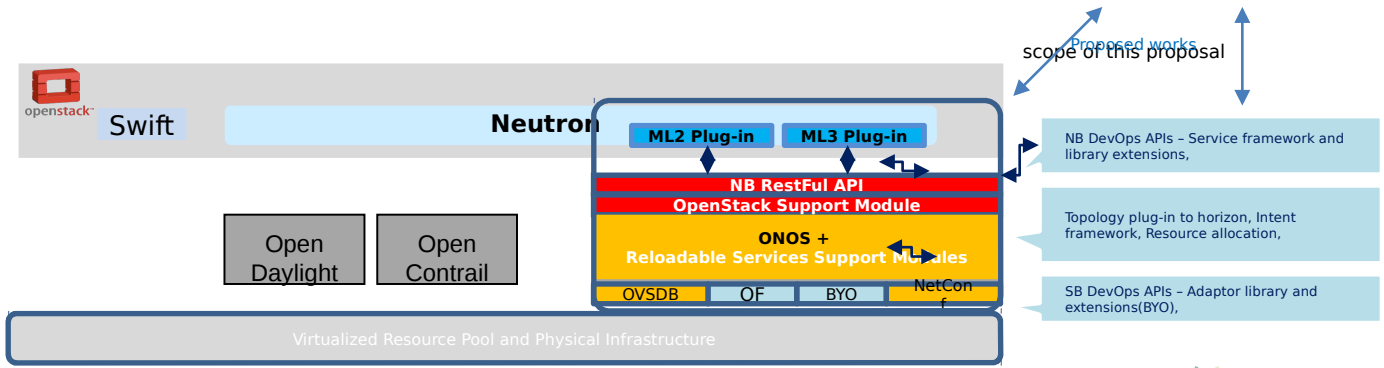
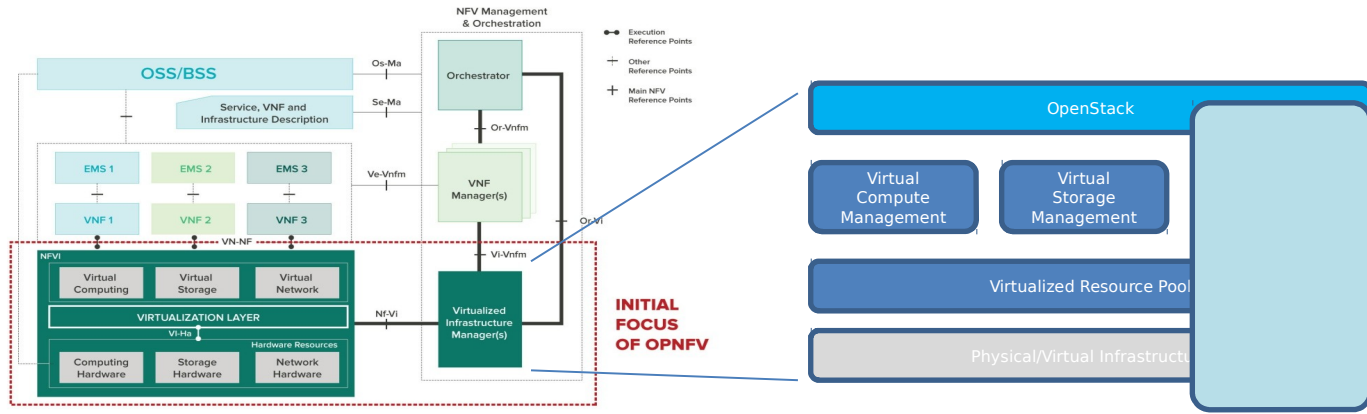

- To be extended
- Ready to be Integrated
- Ready to use

4/18/15

ONOSFW Project Proposal



OPNFV Upstream Project Scope

Setup PATH

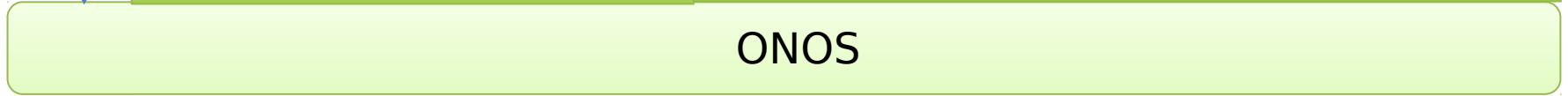
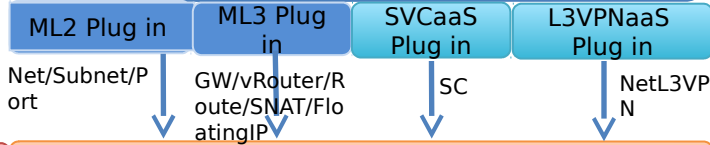
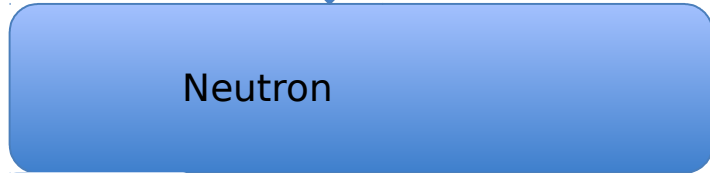
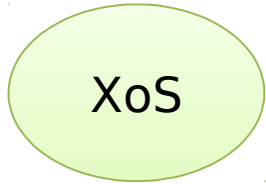

4/18/15



Future Development



OPNFV Upstream - Openstack and ONOS

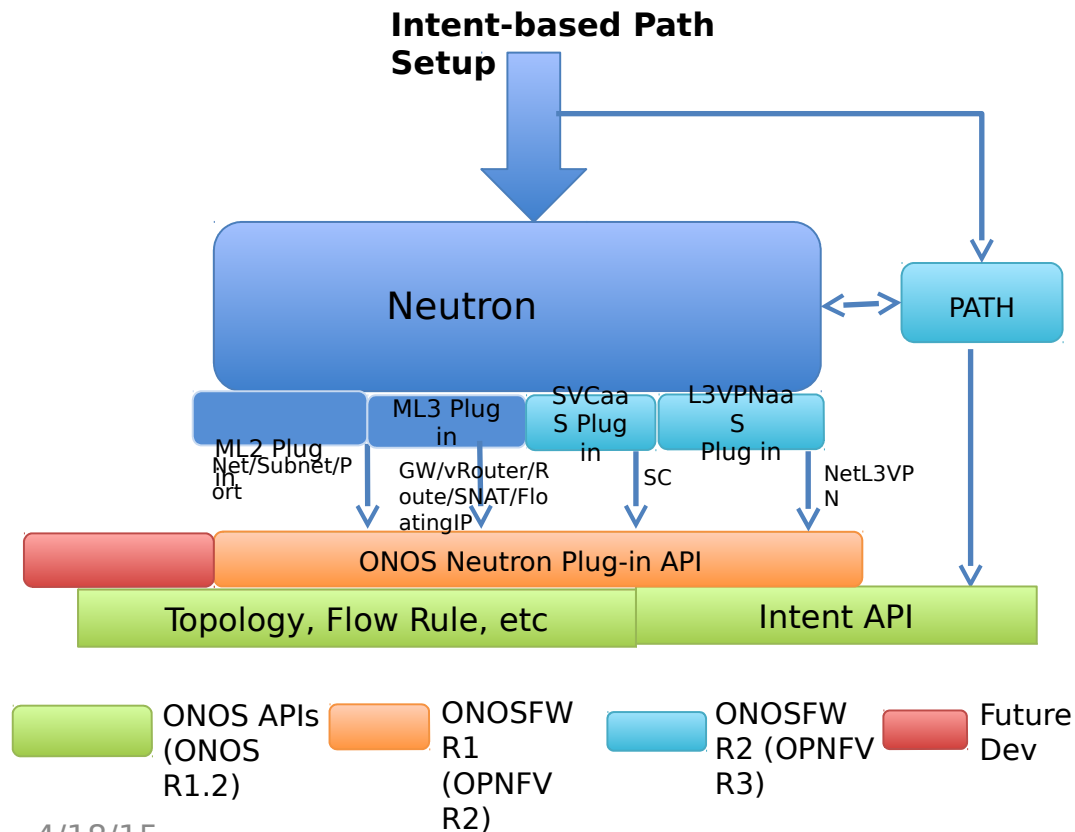

4/18/15

ONOSFW R1: (OPNFV R2)

- ✓ ONOS Neutron ML2 Driver (keep code on Stackforge);
- ✓ ONOS Neutron L3 Driver (keep code on Stackforge) ;
- ✓ Existing IPV6(PD/RA/IPAM) ,VR/DVR BPs in Openstack.
- ✓ System integration and test (HA/scale-out, etc.)

ONOSFW R2: (OPNFV R3)

1. BP for Congress for Policy
2. Add Driver in ONOS for other Controllers
3. Add intent-based PATH manager
4. Neutron API for Intent
5. Consolidate HA & Perf. Bench Marks
6. System integration and test

Future development

1. Extend ONOSFW NB to support different open source cloud management
2. support for possible unifies NBI ?
3. TBD

ML2 ONOSFW Driver and ONOS

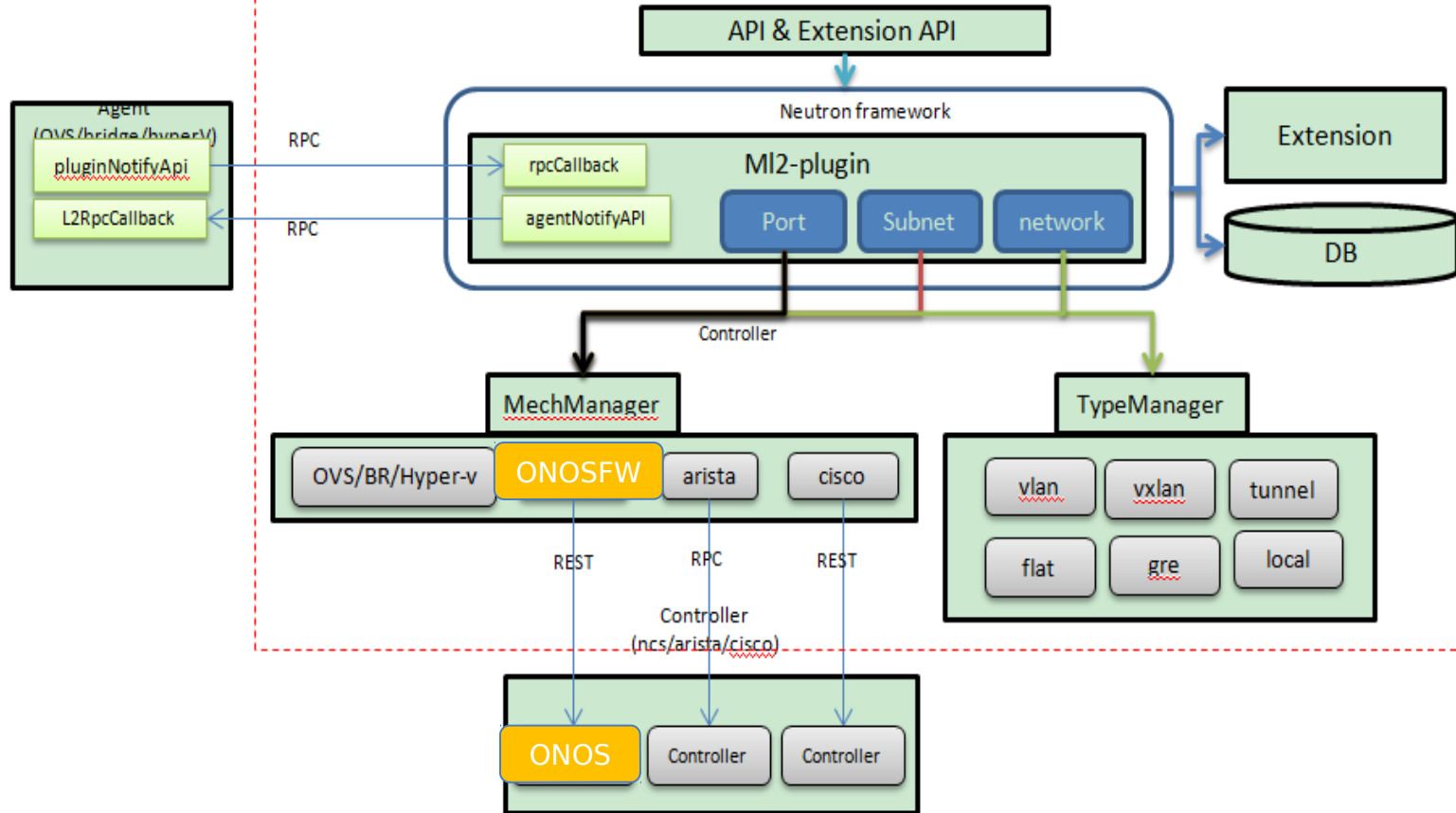

Upstream Collaboration for Development Integration

Project	Mandatory Onosfw r1	Specs	Packages/Rel.	Start	End
ONOSFW	Y	ONOSFW	Openstack (L)+ onos(R1.3)	Spec by May 23	November 10
Neutron	N	API extension	BP in Neutron (L)	Spec by May 23	October 23
Horizon/osc	N	GUI & CLI for ONOSFW	BP in Horizon (L)	Spec by May 23	October 23
Onosfw Keystone onos	N	ID Management/ Phy Infra + Virt. Infra	HL Orchestration (onosfw R1) -> BP in Keystone (L) /onos(R1.3)	Spec by May 23	October 23
Congress	N	Policy /Intent	BP in Congress(L)	Spec by May 23	October 23
Octopus	Y	Automation	Scripts for Build/Test/Deploy	Spec by May 23	Ongoing
Test Software	Y	HA/tests	SDN NB/SB Tools	Spec by May 23	Ongoing

Upstream Collaboration for Development Integration(Cont.)

Project	Mandatory Rel1	Specs	Package/Rel	Start	End
Neutron	N	API	ML2 & ML3 Plug (L)	Spec by May 23	October 23
Neutron	Y	REST calls	ML2 & ML3 Driver (L)	Spec by May 23	October 23
OVSDDB	Y	ONOS SB	OVSDDB(R1.3)	Spec by May 23	October 23
Congress	N	Optional	Policy /Rules (L)	Spec by May 23	October 23
Nova	N	Optional	KVM	N/A	

OPNFV Projects cross-collaboration

	OPNFV Project	ONOSFW	Test Cases	Attributes
1	IPv6 Enabled OPNFV	Use case 1 (CO), Use case 2 MNO	IPv6 Topology	Prefix Delegation
2	Multi-Site OPNFV	Distributed ONOS Core	Parallelism	Distribute Clusters
3	Congress	Intent	Policy	API
4	Promise/vimnbi	Intent NBI	Resource Rsvn	API
5	VNFFG	Path/Link	Graph	API
6	Doctor	Link/State	Notification	API
7	Elevator	Package	Updates	API
8	DP Acceleration	Flow	Cluster	Per Controller
9	4/18/15 Movie	ONOSFW Project Proposal NBI	API	Intent etc

Creating VLAN/VxLAN

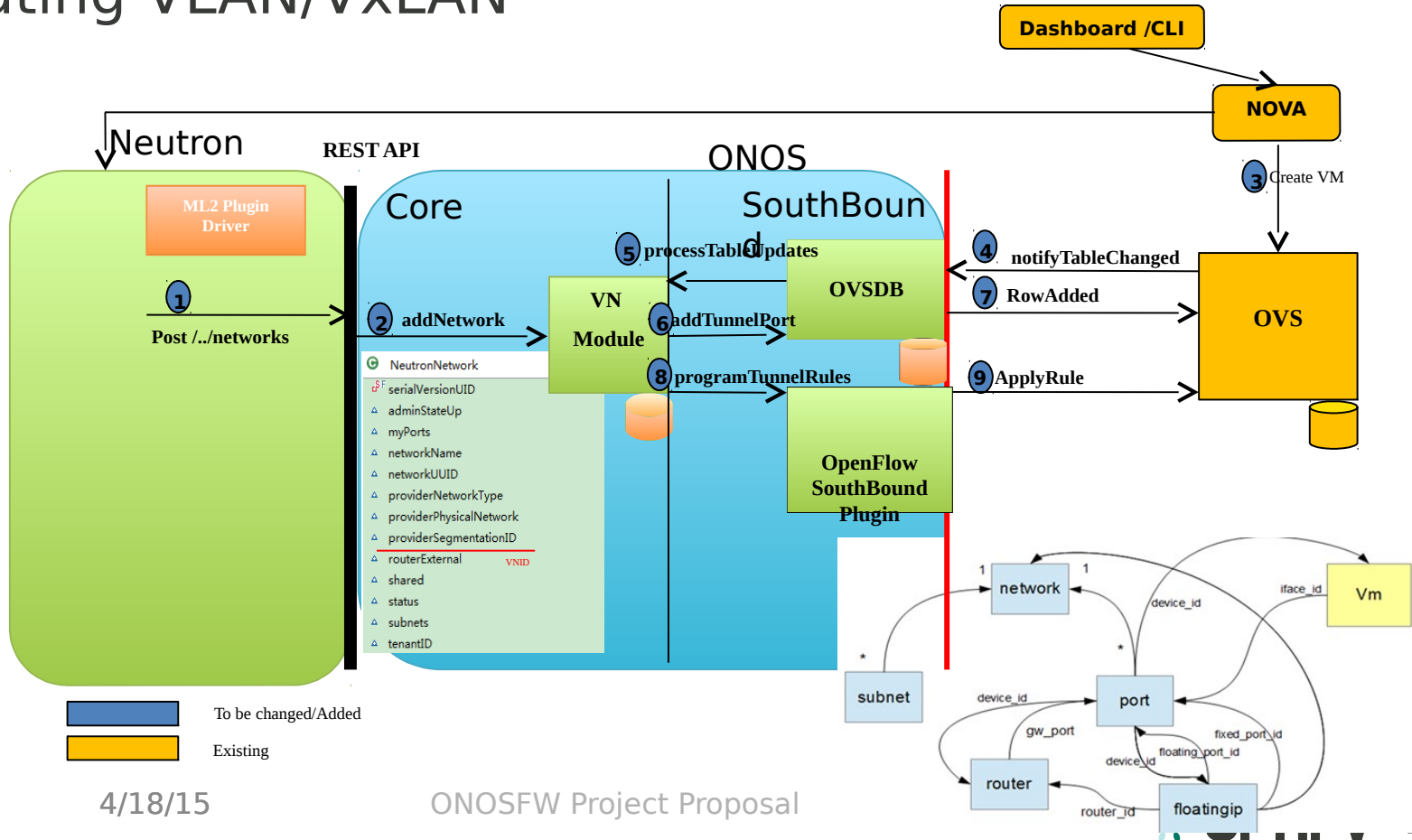

4/18/15

ONOSFW Project Proposal

Message or Control flow for VxLAN Control

```
os> neutron net-create net1
neutron subnet-create net1
10.10.1.0/24 --name sub1
neutron router-create r1
neutron router-interface-add
r1 sub1
os> neutron net-create ext-
net1 -router:external=True
neutron router-gateway-set
r1 ext-net1
os> nova create server vm1
imageRef link1 flavorRef m1
networks net1:port1 uuid1
net2:port2 uuid2
```

```
ml2_conf.ini
[ml2]
type_drivers=local,flat,vlan,gre,vxlan
Mechanism_drivers=onosfw,l2population
Tenant_network_type=vxlan
External_network_type=flat
[ml2_type_vlan]
Vni_range = 1:65535 (1...24bits)
[database]
Connection=mysql://...
[onos]
Local_ip = 192.0.2.24
Enable_tunneling=True
[agent]
Tunnel_type=vxlan
L2_population=True
```

Enterprise L3VPN and vAR in CO Use Case

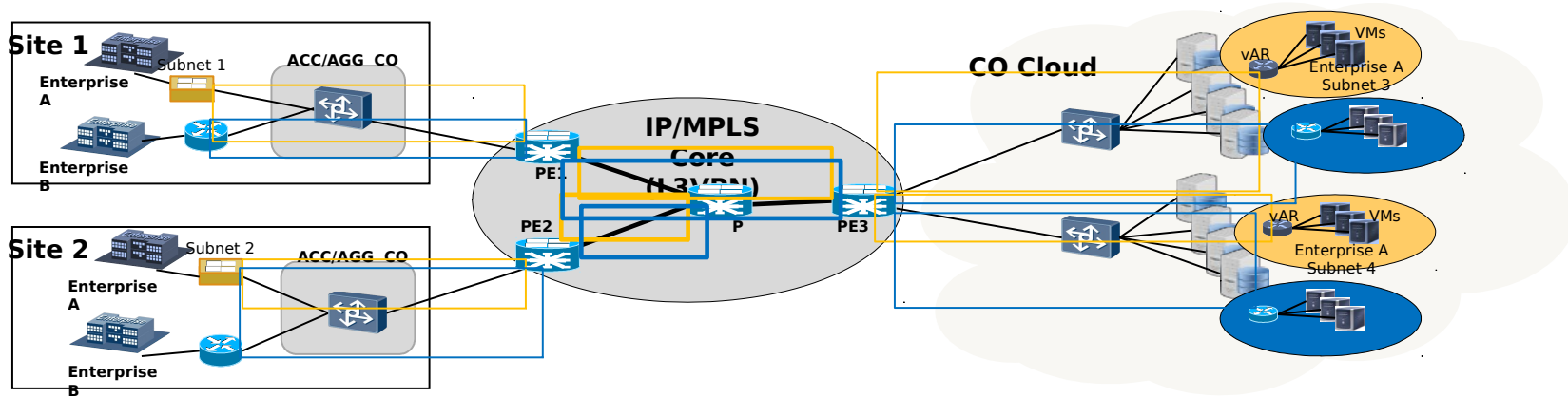

Virtual Router

- › Enterprise/Tenant Virtual Network Routing for Central Office
- › VPN Secure Connection, FW, Load Balancing ...

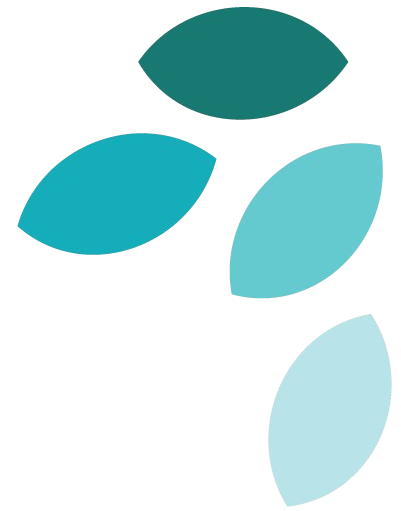

Thank You...

Please direct any questions or comments to forum@onosfw.com or to <http://forum.onosfw.com>

Links to related Open Source Projects

- ONOS wiki
 - <http://onosproject.org/>
- OpenVirteX (OVX) – Programmable Virtual Network
 - <http://ovx.onlab.us/>
- XOS, cloud operating system
 - <http://www.opencloud.us/>

